

外形尺寸图(弯头型)

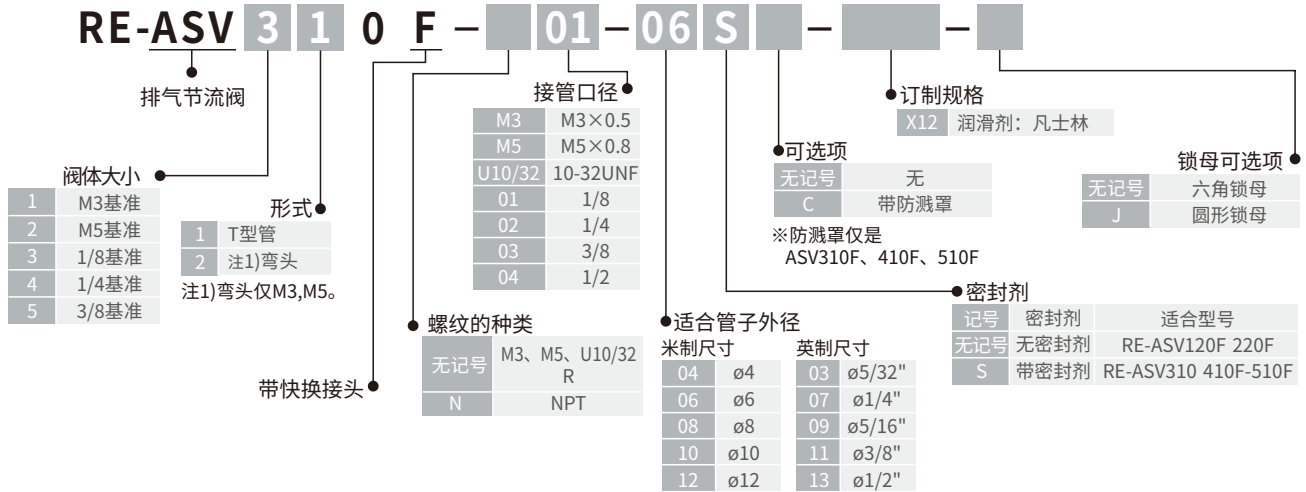

快排阀与排气节流阀一体化。
可用于气缸的高速驱动

- 得到约2倍的有效截面积
(与速度控制阀比较的场合)
对应型号: RE-ASV310F、410F、510F
- 带消声器·快换接头
- 难燃性树脂阀体是标准型(UL规格V-0)
对应型号: RE-ASV310F、410F、510F
- 黄铜零件全是无电解镀膜



图形符号

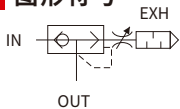

定制规格



润滑剂: 凡士林 X12

(例)RE-ASV120F-M3-04-X12
注1)仅RE-ASV120F.RE-ASV220F对应。

型号

型号	接管口径	适合管子外径(mm)										声速流导 dm³/(s·bar)		临界压力比			
		4	6	8	10	12	5/32"	1/4"	5/16"	3/8"	1/2"	IN-OUT	OUT-EXH	IN-OUT	OUT-EXH		
RE-ASY120F-U3	M3×0.5	●											0.06	0.06			0.15
RE-ASY220F-M5	M5×0.8	●	●										0.26	0.26			
RE-ASY310F-01	R1/8		●	●									1.4	1.6			0.35
RE-ASY310F-02	R1/4		●	●									1.4	1.6			
RE-ASY410F-01	R1/8			●	●								2.7	2.8			0.25
RE-ASY410F-02	R1/4			●	●								2.7	2.8			
RE-ASV410F-03	R3/8			●	●								2.7	2.8			
RE-ASY510F-02	R1/4			●	●	●							4.6	5.4			0.15
RE-ASY510F-03	R3/8			●	●	●							5.4	5.8			
RE-ASY510F-04	R1/2			●	●	●							5.4	5.8			
RE-ASY220F-U10/32	10-32UNF					●	●						0.26	0.26			
RE-ASY310F-N01	NPT1/8						●	●					1.4	1.6			0.35
RE-ASY310F-N02	NPT1/4						●	●					1.4	1.6			
RE-ASY410F-N01	NPT1/8							●	●				2.7	2.8			0.35
RE-ASY410F-N02	NPT1/4							●	●				2.7	2.8			
RE-ASY410F-N03	NPT3/8								●	●			2.7	2.8			
RE-ASV510F-N02	NPT1/4									●	●		4.6	5.4			
RE-ASY510F-N03	NPT3/8									●	●		5.4	5.8			
RE-ASY510F-N04	NPT1/2										●	●	6.4	5.			

规格

型号	RE-ASV120F	RE-ASV220F	RE-ASV310F、410F	RE-ASV510F
使用流体	空气			
保证耐压力	1.5MPa			
最高使用压力	1MPa			
最低使用压力	0.1MPa			
环境温度及使用流体温度	-5~60°C(未冻结)			
适用管子材质	尼龙、软尼龙、聚氨酯			
可选项	圆形锁母		带防溅罩、圆形锁母	

注1)注意软尼龙、聚氨酯的最高使用压力。

针阀/流量特性

RE-ASV120F 流量
OUT-EXH.

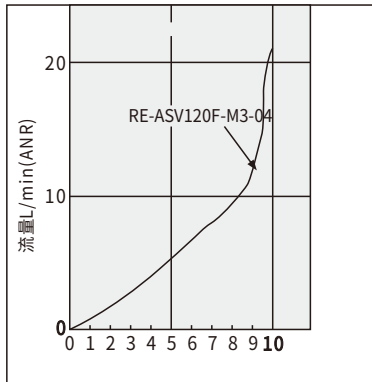

针阀回转数 圈

RE-ASV310F 流量
IN-OUT

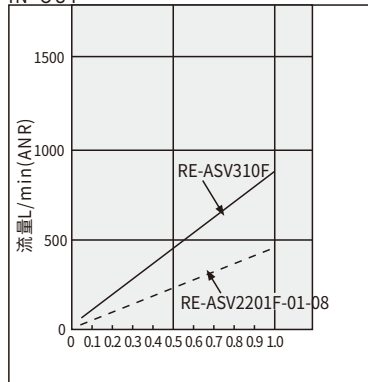

一次侧压力: 0.5MPa

OUT-EXH. 流量

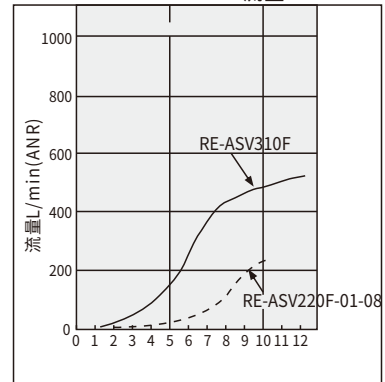

针阀回转数 圈

RE-ASV220F 流量
OUT-EXH.

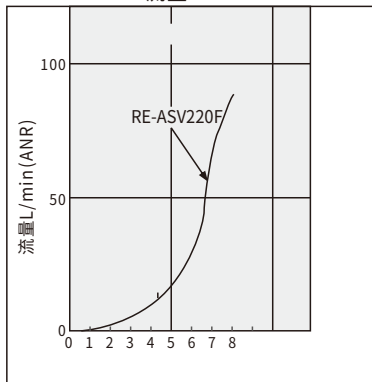

针阀回转数 圈

RE-ASV410F 流量
IN-OUT

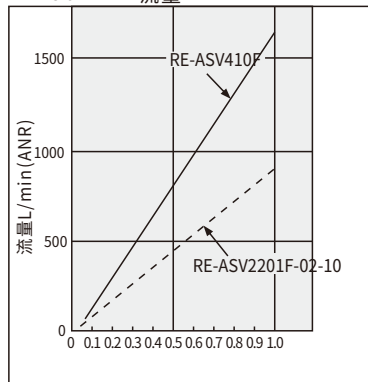

一次侧压力: 0.5MPa

OUT-EXH. 流量

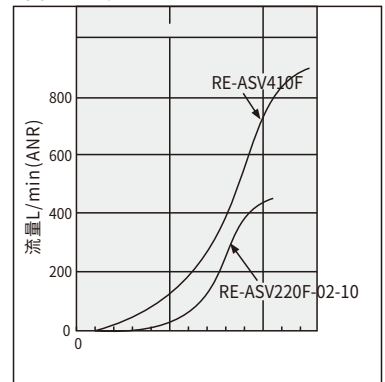

针阀回转数 圈

RE-ASV510F 流量
IN-OUT

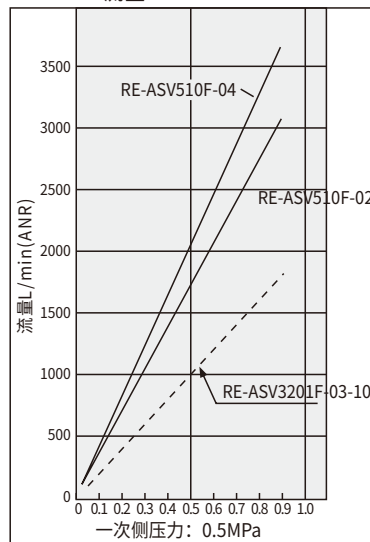

一次侧压力: 0.5MPa

OUT-EXH. 流量

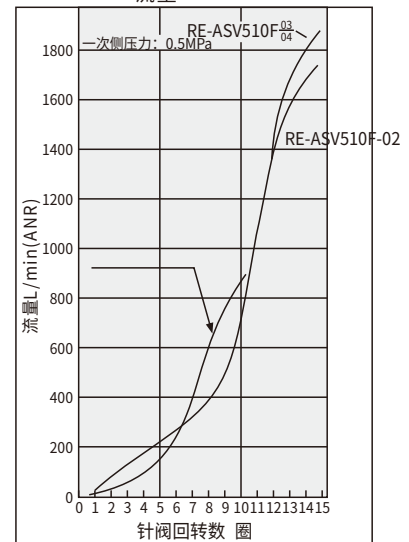

针阀回转数 圈

外形尺寸图

RE-ASV120F·220F

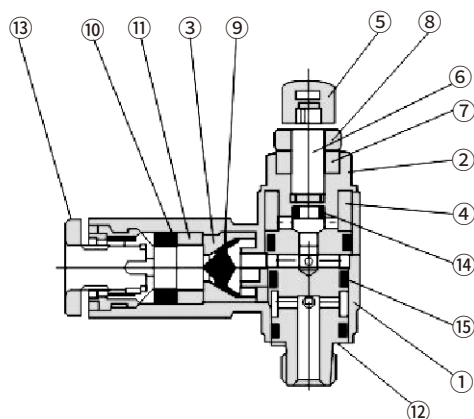

构成零部件

序号	零部件名	材质	备注
1	阀体A	PBT	
2	阀体B	黄铜 ^{注1)}	无电解镀镍
3	阀座环	黄铜	无电解镀镍
4	消声材料	PVA海绵	
5	手轮	PBT	M3形式: 黄铜无电解镀镍
6	针阀	黄铜	无电解镀镍
7	针阀导座	黄铜	无电解镀镍
8	锁母	钢注3)	铬酸锌 ^{注2)}
9	阀芯	HNBR	
10	密封件	NBR	
11	隔环	POM	
12	密封垫	不锈钢/NBR	M3形式为PVC
13	释放套	—	
14	O形圈	NBR	
15	O形圈	NBR	

注1)M3形式为不锈钢。
 注2)圆形锁母为无电解镀镍。
 注3)圆形锁母为黄铜。

RE-ASV310F·410F·510F

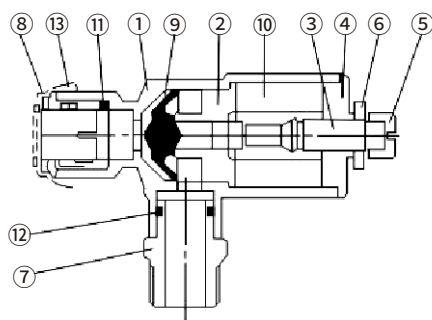

构成零部件

件号	零部件名	材质	备注
1	阀体A	PBT	UL94V-0
2	阀座环	铝合金	铬酸盐处理
3	针阀	铝合金	无电解镀镍
4	针阀导座	铝合金	无电解镀镍
5	手轮	黄铜	无电解镀镍
6	锁母	钢 ^{注2)}	铬酸锌 ^{注1)}
7	压入接头	黄铜	无电解镀镍
8	释放套	—	
9	阀芯	聚氨酯橡胶	
10	消声材料	PVA海绵	
11	密封件	NBR	
12	O形圈	NBR	
13	罩	难燃CR	UL94V-0

注1)圆形锁母为无电解镀镍。
 注2)圆形锁母为黄铜, 但RE-ASV310F、RE-ASV410F为钢

回路图

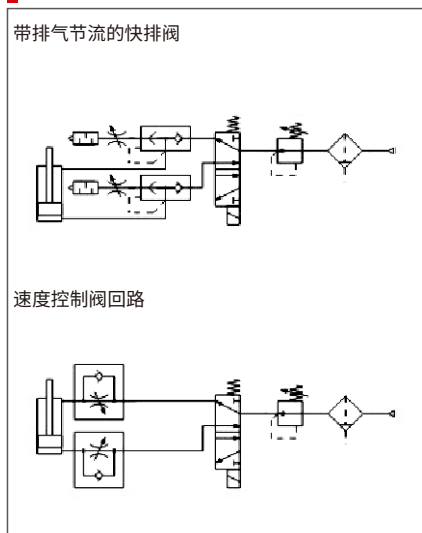

设计上的注意/选定.

⚠ 注意

- ①以下场合, 由于排气不良和发振, 有产生噪声的可能。
- (a) IN侧有残压、背压的场合。
 - (b) IN侧和OUT侧的差压比最低使用压力小的场合。
 - (c) RE-ASV的IN侧配管和电磁阀的有效截面积比都RE-ASV小的场合。

外形尺寸图

RE-ASV120F·220F

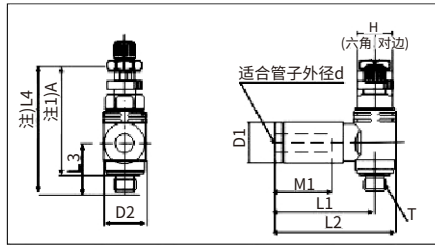

米制尺寸

型号	适合管子 外径d	T	H	D1	D2	L1	L2	L3	L4		※A		M1	质量g
									Max.	Min.	Max.	Min.		
RE-ASV120F-M3-04	4	M3×0.5	5.5	9.3	7.2	21.4	25	9.8	28.6	26.1	25.8	12.7	12.7	5
RE-ASV220F-M5-04	4	M5×0.8	8	9.3	9.6	22.8	27.6	11.1	31.4	28.6	27.7	12.7	12.7	8
RE-ASV220F-M5-06	6	M5×0.8	8	11.6	9.6	23.6	28.4	11.1	31.4	28.6	27.7	13.5	13.5	9

注1)M螺纹的螺纹拧入后的参考尺寸 注2)L4是参考尺寸。

英制尺寸

型号	适合管子 外径d	T	H	D1	D2	L1	L2	L3	L4		※A		M1	质量g
									Max.	Min.	Max.	Min.		
RE-ASV220F-U10/32-03	5/32"	10-32UNF	8	9.3	9.6	22.8	27.6	11.1	31.4	28.6	27.7	24.9	12.7	8
RE-ASV220F-U10/32-07	1/4"	10-32UNF	8	12	9.6	23.6	28.4	11.1	31.4	28.6	27.7	24.9	13.7	9

注1)U10/32螺纹的螺纹拧入后的参考尺寸 注2)L4是参考尺寸。

RE-ASV310F、410F、510F

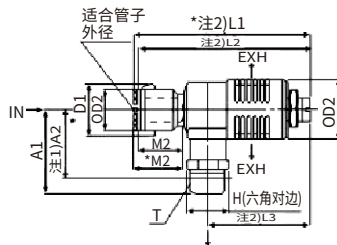

米制尺寸

型号	适合管子 外径d	T	H	D1	D2	D3	L1		L2		L3		注2)A1	A2	M1	*M2	质量g
							Max.	Min.	Max.	Min.	Max.	Min.					
RE-ASV310F-01-06S	6	R1/8	10	16.8	12.8	17.6	71.9	65.9	69.9	63.9	45.8	39.8	26.5	23.4	17	19	22
RE-ASV310F-01-08S	8	R1/8	10	19.3	15.2	17.6	73.8	67.8	71.8	65.8	45.8	39.8	30.9	25.4	19	21	23
RE-ASV310F-02-06S	6	R1/4	14	16.8	12.8	17.6	71.9	65.9	69.9	63.9	45.8	39.8	30.9	25.4	17	19	30
RE-ASV310F-02-08S	8	R1/4	14	19.3	15.2	17.6	73.8	67.8	71.8	65.8	45.8	39.8	30.9	25.4	19	21	31
RE-ASV410F-01-08S	8	R1/8	12	19.3	15.2	24	83.1	75.6	81.1	73.6	52.8	45.3	29.8	26.7	19	21	39
RE-ASV410F-01-10S	10	R1/8	12	23.3	18.5	24	85.2	77.7	83.2	75.7	52.8	45.3	29.8	26.7	21	23	41
RE-ASV410F-02-08S	8	R1/4	14	19.3	15.2	24	83.1	75.6	81.1	73.6	52.8	45.3	34.2	28.7	19	21	47
RE-ASV410F-02-10S	10	R1/4	14	23.3	18.5	24	85.2	77.7	83.2	75.7	52.8	45.3	34.2	28.7	21	23	49
RE-ASV410F-03-08S	8	R3/8	17	19.3	15.2	24	83.1	75.6	81.1	73.6	52.8	45.3	35.0	30.4	19	21	61
RE-ASV410F-03-10S	10	R3/8	17	23.3	18.5	24	85.2	77.7	83.2	75.7	52.8	45.3	35.0	30.4	21	23	63
RE-ASV510F-02-10S	10	R1/4	17	23.3	18.5	30	88.2	82.2	86.2	80.2	53.6	47.6	39.3	33.8	21	23	69
RE-ASV510F-02-12S	12	R1/4	17	25.7	20.9	30	89.8	83.8	87.8	81.8	53.6	47.6	39.3	33.8	22	24	74
RE-ASV510F-03-10S	10	R3/8	17	23.3	18.5	30	88.2	82.2	86.2	80.2	53.6	47.6	40.7	35.5	21	23	73
RE-ASV510F-03-12S	12	R3/8	17	25.7	20.9	30	89.8	83.8	87.8	81.8	53.6	47.6	40.7	35.5	22	24	78
RE-ASV510F-04-10S	10	R1/2	22	23.3	18.5	30	88.2	82.2	86.2	80.2	53.6	47.6	44.9	37.0	21	23	95
RE-ASV510F-04-12S	12	R1/2	22	25.7	20.9	30	89.8	83.8	87.8	81.8	53.6	47.6	44.9	37.0	22	24	100

★：带罩场合的尺寸。 注1)R螺纹的螺纹拧入后的参考尺寸。 注2)L1, L2, L3是参考尺寸。

英制尺寸

型号	适合管子 外径d	T	H	*D1	D2	D3	*L1		L2		L3		注2)A1	注1)A2	M1	*M2	质量g
							Max.	Min.	Max.	Min.	Max.	Min.					
RE-ASV310F-N01-07	1/4"	NPT1/8	12.7	17.2	13.2	17.6	73	67	71	65	45.8	39.8	26.5	23.4	16.8	18.8	22
RE-ASV310F-N01-09	5/16"	NPT1/8	12.7	19.3	15.2	17.6	73.8	67.8	71.8	65.8	45.8	39.8	30.9	25.4	19	21	23
RE-ASV310F-N02-07	1/4"	NPT1/4	14.3	17.2	13.2	17.6	73	67	71	65	45.8	39.8	30.9	25.4	16.8	18.8	30
RE-ASV310F-N02-09	5/10"	NPT1/4	14.3	19.3	15.2	17.6	73.8	67.8	71.8	65.8	45.8	39.8	30.9	25.4	19	21	31
RE-ASV410F-N01-09	5/16"	NPT1/8	12.7	19.3	15.2	24.4	83.1	75.6	81.1	73.6	52.8	45.3	20.8	26.7	19	21	39
RE-ASV410F-N01-11	3/16"	NPT1/8	12.7	23.3	18.5	24.4	85.2	77.7	83.2	75.7	52.8	45.3	20.8	26.7	21	23	41
RE-ASV410F-N02-09	5/16"	NPT1/4	14.3	19.3	15.2	24.4	83.1	75.6	81.1	73.6	52.8	45.3	34.2	28.7	19	21	47
RE-ASV410F-N02-11	3/16"	NPT1/4	14.3	23.3	18.5	24.4	85.2	77.7	83.2	75.7	52.8	45.3	34.2	28.7	21	23	49
RE-ASV410F-N03-09	5/16"	NPT3/8	17.5	19.3	15.2	24.4	83.1	75.6	81.1	73.6	52.8	45.3	35.6	30.4	19	21	61
RE-ASV410F-N03-11	3/16"	NPT3/8	17.5	23.3	18.5	24.4	85.2	77.7	83.2	75.7	52.8	45.3	35.6	30.4	21	23	63
RE-ASV510F-N02-11	3/16"	NPT1/4	17.5	23.3	18.5	30	88.2	82.2	86.2	80.2	53.0	47.6	39.3	33.8	21	23	69
RE-ASV510F-N02-13	1/2"	NPT1/4	17.5	26.5	21.7	30	89.8	83.8	87.8	81.8	53.0	47.6	39.3	33.8	21.8	23.8	74
RE-ASV510F-N03-11	3/16"	NPT3/8	17.5	23.3	18.5	30	88.2	82.2	86.2	80.2	53.6	47.6	40.7	35.5	21	23	73
RE-ASV510F-N03-13	1/2"	NPT3/8	17.5	26.5	21.7	30	89.8	83.8	87.8	81.8	53.6	47.6	40.7	35.5	21.8	23.8	78
RE-ASV510F-N04-11	3/16"	NPT1/2	22.2	23.3	18.5	30	88.2	82.2	86.2	80.2	53.6	47.6	44.9	37.6	21	23	95
RE-ASV510F-N04-13	1/2"	NPT1/2	22.2	26.5	21.7	30	89.8	83.8	87.8	81.8	53.6	47.6	44.9	37.6	21.8	23.8	100

★：带罩场合的尺寸。 注1)NPT螺纹的螺纹拧入后的参考尺寸。 注2)L1, L2, L3是参考尺寸。